

# Which battery-powered water meters ensure reliable long-term accuracy?

---



SITRANS F M MAG 8000 electromagnetic water meters offer cost-efficient, MI-001 approved solutions - easy to install and maintain.

Answers for industry.

**SIEMENS**

# World-class battery solution



The SITRANS F M MAG 8000 program of battery-operated flowmeters combines world-class performance with dedicated application solutions and low cost of ownership. No mains power required.

The MAG 8000 / MAG 8000 CT combines high-efficiency technology and advanced power management:

- **Battery power management**  
Optimal control of power consumption ensures long operation time and reduces the number of site visits

- **10 years maintenance-free operation**  
6 years operation time of the internal battery and an external battery pack with a 10-year life
- **Low battery alarm**  
A customer-selectable "low battery" level setting with call-up alarm lets you know when it's time to replace the battery.

Flexible power supply			
			
Internal 6-year life battery pack	Mains power supply	Mains power supply with up to 3 years of battery backup	External 10-year life battery pack

- Replaceable internal battery pack
- Internal mains power supply, 12 – 24 V AC/DC and 115 – 230 V AC with battery backup
- External battery pack with waterproof connectors (IP68 / NEMA 6P)

# One meter for all stand-alone water applications



	MAG 8000	MAG 8000 CT	MAG 8000 Irrigation
<b>Application</b>	Abstraction and distribution networks	Revenue and bulk metering	Irrigation
<b>Transmitter type</b>	Basic version for general purpose use Advanced version for advanced information and functionality		Basic version
<b>Custody transfer version</b>	Type-approved and verified according to OIML R 49 / MI-001		** NMI 10
<b>Sensor size DN</b>	25 – 1200 mm / 1" – 48" with EPDM liner	* 50 – 300 mm / 2" – 12" with EPDM liner	50 - 600 mm
<b>Enclosure sensor and transmitter</b>	IP68 / NEMA 6P, compact and remote with connectors and factory-mounted cable		
<b>Display</b>	Display with touch keypad		
<b>Output</b>	2 individual pulse outputs (incl. net flow volume)		
<b>Communication</b>	Integrated standard IrDA interface, add-on communication modules, RS 232 / RS 485 with MODBUS RTU protocol, encoder interface module (output) with sensus protocol		
<b>Power supply</b>	Internal or external battery pack 12 – 24 V AC/DC and 115 – 230 V AC with battery backup		
<b>Certifications</b>	MAG 8000 is approved to the international water meter standard OIML R 49/MI-001 (EU), complying with the European CEN – EN 14154 and ISO 4064 specifications		** NMI 10
<b>Transmitter features</b>	Data logger with selectable log interval up to 26 months, time and date, data protection, application identifier, alarm handling, meter status, diagnostics, battery power management Advanced version only (not valid for MAG 8000 I): Leakage detection, flow statistics and consumption profile, advanced diagnostics, self-check, insulation test, meter utilization, tariff and settle date (revenue)		
<b>Accuracy</b>	0.4% ± 2 mm/s (DN 25 - 1200 / 1" – 48") 0.2% ± 2 mm/s (DN 50 - 300 / 2" – 12")	OIML R 49 Class 1 and 2 MI-001 Class 2	0.8% ± 2.5 mm/s
<b>Bi-directional measurement</b>	Yes		
<b>Drinking water approvals for sensor part</b>	ACS (France), WRc (UK), DVGW (Germany), NSF/ANSI Standard 61 (USA) and Belgaqua (Belgium)		NSF/ANSI Standard 61 (USA)
<b>Process connections</b>	EN 1092-1 (DIN 2501), ANSI 16.5 Class 150 lb , AS 4087, and AWWA C207		Flange drilled according to EN, ANSI OVAS
<b>Operating pressure</b>	PN 10 or PN 16 / 145 psi or 232 psi		Max. 7 bar
<b>Media temperature</b>	0 – 70°C / 32 – 158 °F	0.1 – 50°C / 32 – 122°F	0 – 70°C / 32 – 158 °F
<b>Electrodes and earthing electrodes</b>	Hastelloy C276		Stainless steel

\* Up to DN 600 / 24" in preparation \*\* In preparation

# The water meter of choice for water supply and metering



## Distribution and abstraction

To ensure consumers receive a continuous flow of drinkable water, more and more water meters are installed in the network to monitor the water flow from trunk lines to local systems.

- Bi-directional flow - one solution for all purposes
- Network load monitoring - reduces leakage and saves energy
- Early leakage detection - reliable and repeatable measurements of low flow at night aid in early leakage detection

## Bulk water / revenue metering

To ensure water bills are fair, and to reduce the need for verification, usage must be measured cost-effectively and accurately.

- MAG 8000 CT is Custody Transfer approved according to global revenue standards - reliable and fair water billing
- No moving parts - minimal maintenance requirements making MAG 8000 the best choice when it comes to optimizing costs

## Irrigation

Where irrigation systems are used in crop production, MAG 8000 Irrigation ensures water wastage is kept to a minimum and that farmers get a fair deal.

- No moving parts - not prone to wear and tear in the usual way
- IP68 / NEMA 6P enclosure - allows installation in places where flooding can occur, or even complete underground burial
- Battery power option - secures long-term performance in regions lacking reliable mains power



**Distribution and abstraction:**  
MAG 8000 minimizes maintenance and detects leaks early



**Bulk water / revenue metering:**  
MAG 8000 monitors consumption accurately and economically



**Irrigation:** MAG 8000 delivers robust long-term performance for optimal cost of ownership



**Installation made simple**

With the MAG 8000 range it is easy to install a reliable water meter, compact or remote, in virtually any environment, whilst maintaining full accuracy, performance and economy of operation.

With its sturdy construction, the MAG 8000 / MAG 8000 CT is built to resist environmental factors such as water containing solids and debris.

**Reliable and robust it features:**

- Remote transmitter solution with factory-mounted sensor cables and connectors
- No moving parts resulting in less wear and tear
- Bidirectional accuracy
- Underground installation – sensor can be buried – no manhole required
- IP68 / NEMA 6P enclosure and cable designed to withstand constant flooding
- Durability against
  - high/low temperature
  - flooding and high humidity
  - erosion
- Easy Installation
  - Simply bolt into place before operation
  - Minimized inlet and outlet requirements
  - No additional connection or set-up is required to operate the meter
  - No filter required

Installation virtually anywhere



Easy installation

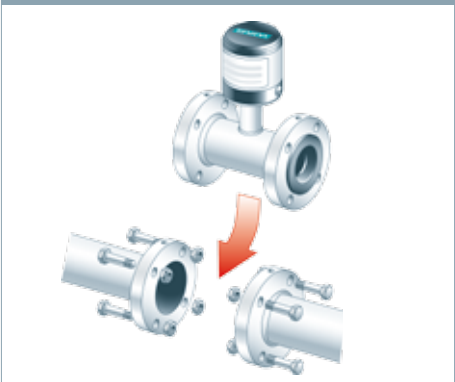

IP68 / NEMA 6P enclosure



# Intelligence at your fingertips



## Qualification Certificate

The SIMATIC PDM tool allows on-site testing and verification of the water meter, and creates a printed "Qualification Certificate" with specific data defining the quality status of the measurement.

The future-proof open communication platform makes network integration easy both today and tomorrow. Advanced self-diagnostics perform a wide range of essential checks and data analyses automatically.

## Unmatched data security

MAG 8000 stores relevant meter and application data:

- Consumption logging storing up to 26 months of data
- Consumption profile
- Tariff control on time and flow rate
- Pre-account settling date function that automatically stores the totalizer value on a specific date
- Data protection and backup secured via EEPROM

## Excellent monitoring

The MAG 8000 monitors itself and the installation and notifies in case of irregularities:

- Leakage detection program that measures and monitors the lowest flow value within a customer-selected time frame each 24 hours. Observed changes during this period could indicate when a leak started
- Meter and application diagnostics
- Meter status and alarm handling

### Easy-to-read display

Graphical display and keypad for simple operation and instant access to information.

MAG 8000 / MAG 8000 CT advanced version provides intelligent information with an on-site display.

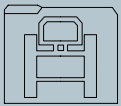

Meter information

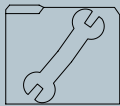

Service



Data logger

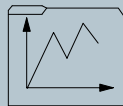

Statistics



Revenue



### Low on running costs

Once installed, a number of performance-enhancing features ensure that maintenance requirements are restricted to an absolute minimum:

- An electrode resistance module measures the meter's contact with the media
- A program indicates whether the size of the meter selected is appropriate for the flow conditions on site
- A comprehensive data logging function records and stores consumption levels, alarms and operating conditions from the site
- Documentation of operation conditions with on-board meter self-check and diagnostics of application conditions

### Insulation test

Built-in "cross-talk" test checks the entire signal chain of the system ensuring that the sensor flow signal is unaffected by external noise.

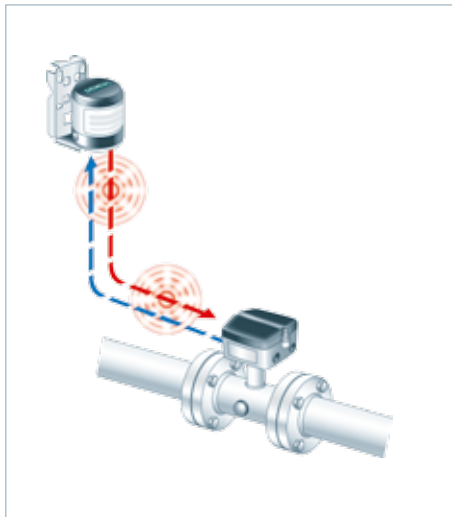

### Low-flow detection

Siemens conical flow tube design improves low-flow performance. Insignificant pressure drop across the meter and thus reduced energy loss.

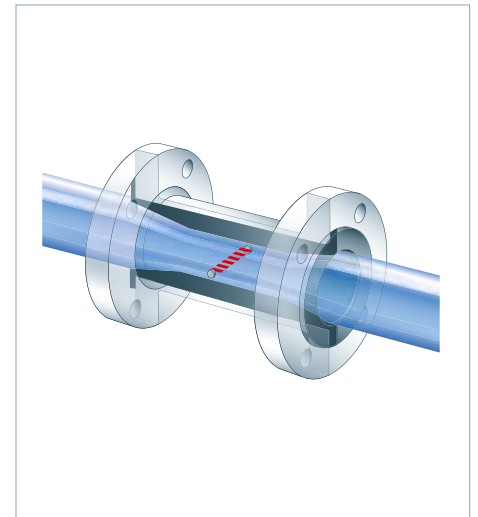

# Data flows better with Siemens solutions

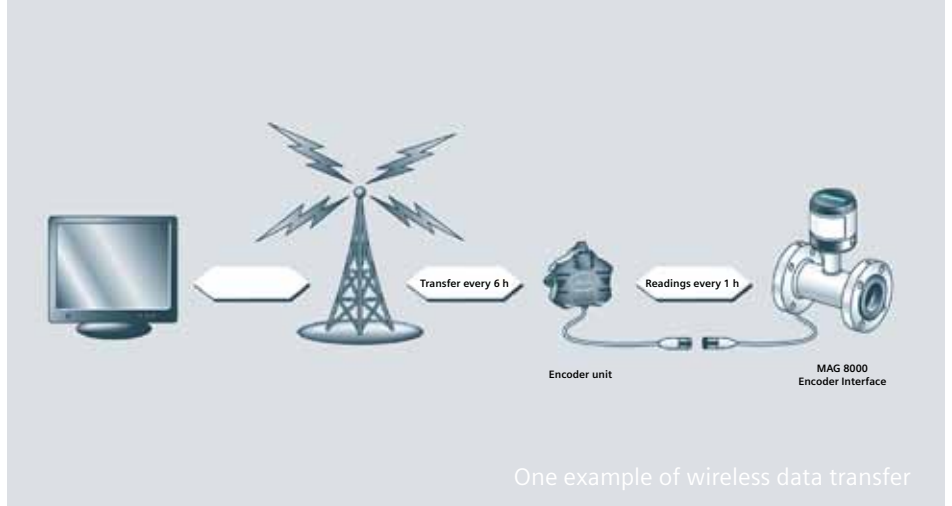

With advanced display information, on-site data collection and remote monitoring via communication networks, MAG 8000 makes sure you get all the information you need.

## Wireless solution

Siemens offers the base for a complete wireless automated meter reading (AMR) solution designed for use in Water Fixed Networks. Data from the site can be directly accessed over the Internet using a standard browser and secure password protection.

## AMR gives you:

- increased operational efficiency
- improved control of operational costs
- improved resource conservation

## Easy access to data on-site

Standard IrDA interface for configuration, data collection and documentation using Siemens PDM (Process Device Manager) or Flow Tool Software.

## Add-on communication

Communication modules can be installed if network capability is required:

- Modbus RTU RS232
- Modbus RTU RS485
- Encoder output option "Sensus Protocol"

Simulation checks that information flows correctly, and is configured via the standard IrDA interface or the communication channel.

Flow simulation



Add-on communication





# Accredited calibration ensures accuracy

The maximum uncertainty of measurement following a standard calibration is  $\pm 0.4\%$ , and an extended calibration  $\pm 0.2\%$ .

A calibration certificate is supplied with every water meter, and calibration data are stored in the instrument.

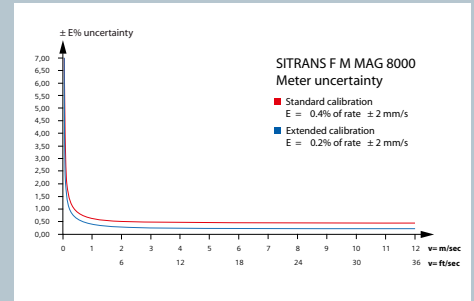
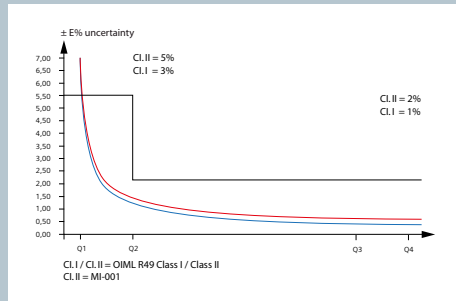

Validated calibration ensures accurate water measurement. Every Siemens water meter is calibrated in-house at facilities that are individually accredited in accordance with ISO / IEC 17025.

The accuracy of each water meter is determined by the type of calibration performed. MAG 8000 / MAG 8000 CT water meters are available with three types of calibration, suited to different application requirements.

Calibration type	Application	Accuracy	Water meter type
Standard	General water applications	0.4 %	MAG 8000
Extended	High-performance applications	0.2 %	
Bulk water / revenue	Custody transfer applications (CT)	Class 1: 1% at low flow 3% Class 2: 2% at low flow 5%	MAG 8000 CT

MAG 8000 / MAG 8000 CT revenue meters are verified in accordance with the Measuring Instruments Directive 2004 (MID) for custody transfer applications, comprising the following approvals.

MID module	Approval	Geographical applicability
MID Class II Module B	OIML R 49, OIML R 49 MAA type approval	Worldwide
	MI-001 approval	European Union
MID Class II Module D	Production quality management system approval (first time inhouse certification)	European Union

## Get more information

Find everything about Flow Instruments:

[www.siemens.com/flow](http://www.siemens.com/flow)

Explore the unique range of Process Instrumentation portfolio:

[www.siemens.com/processinstrumentation](http://www.siemens.com/processinstrumentation)

Learn more about Process Automation:

[www.siemens.com/processautomation](http://www.siemens.com/processautomation)

Siemens A/S  
Flow Instruments  
DK-6430 NORDBORG

Headquarter:  
Siemens A/S  
DK-2750 BALLERUP

Subject to change without prior notice  
Order No.: E20001-A40-P730-V2-7600  
DISPO 27900  
WS091007.0  
Printed in Denmark  
© Siemens AG 2010

The information provided in this brochure contains merely general descriptions or characteristics of performance which in case of actual use do not always apply as described or which may change as a result of further development of the products. An obligation to provide the respective characteristics shall only exist if expressly agreed in the terms of contract.

All product designations may be trademarks or product names of Siemens AG or supplier companies whose use by third parties for their own purposes could violate the rights of the owners.